



duotank
TANKBEER SYSTEMS



Standard Pricelist Tanks & Equipment

Insulated - PED 1 Feb 2026- 1 Feb 2027

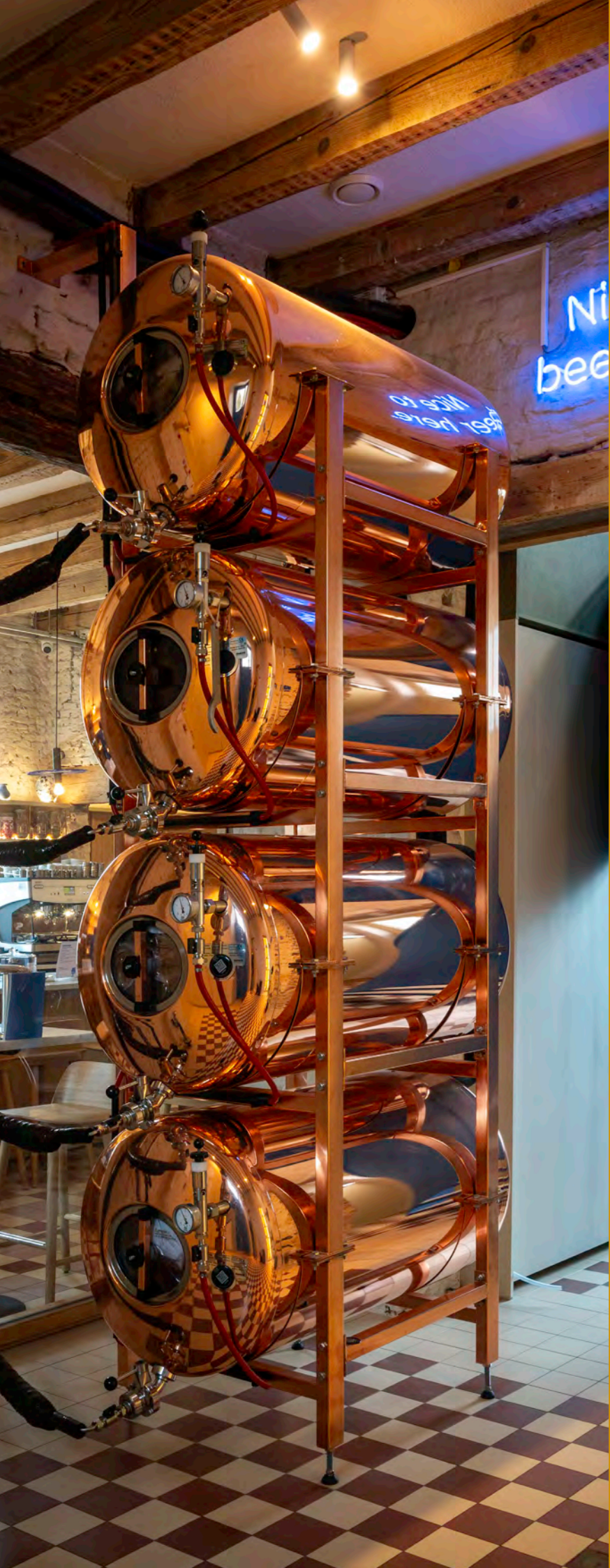

Duotank - Tankbeer Systems develops, produces, and installs tank beer systems. Since 1985, we have been designing, developing, and manufacturing systems that lead to optimal results for beer breweries worldwide.

Duotank Tankbeer Systems focuses on quality, craftsmanship, and cooperation. We understand each customer has its own preferences and unique problem definitions, and therefore, we also strive to offer case-specific solutions.



Index

Double walled system	4
2.5 HL Insulated horizontal	6
2.5 HL Insulated DB	10
2.5 HL Insulated vertical	14
5 HL Insulated horizontal	20
5 HL Insulated DB	24
5 HL Insulated vertical	28
10 HL Insulated horizontal	34
Components	39
Non-Insulated Tanks	45

Important note:

The article codes in this catalogue are based on our standard NW25. Upon request, all tanks can also be supplied with NW32 and NW40 outlets.

Please contact your Duotank agent for more information.

1. Insulated tank
2. Beerliner
3. Pressure reducing valve
4. Safety valve
5. Piercing unit
6. Compressor
7. Pump
8. Cooler
9. Phyton
10. Frame
11. DSO
12. Beer manifold

The construction of the insulated tank beer installation

45° NW 25 - PED

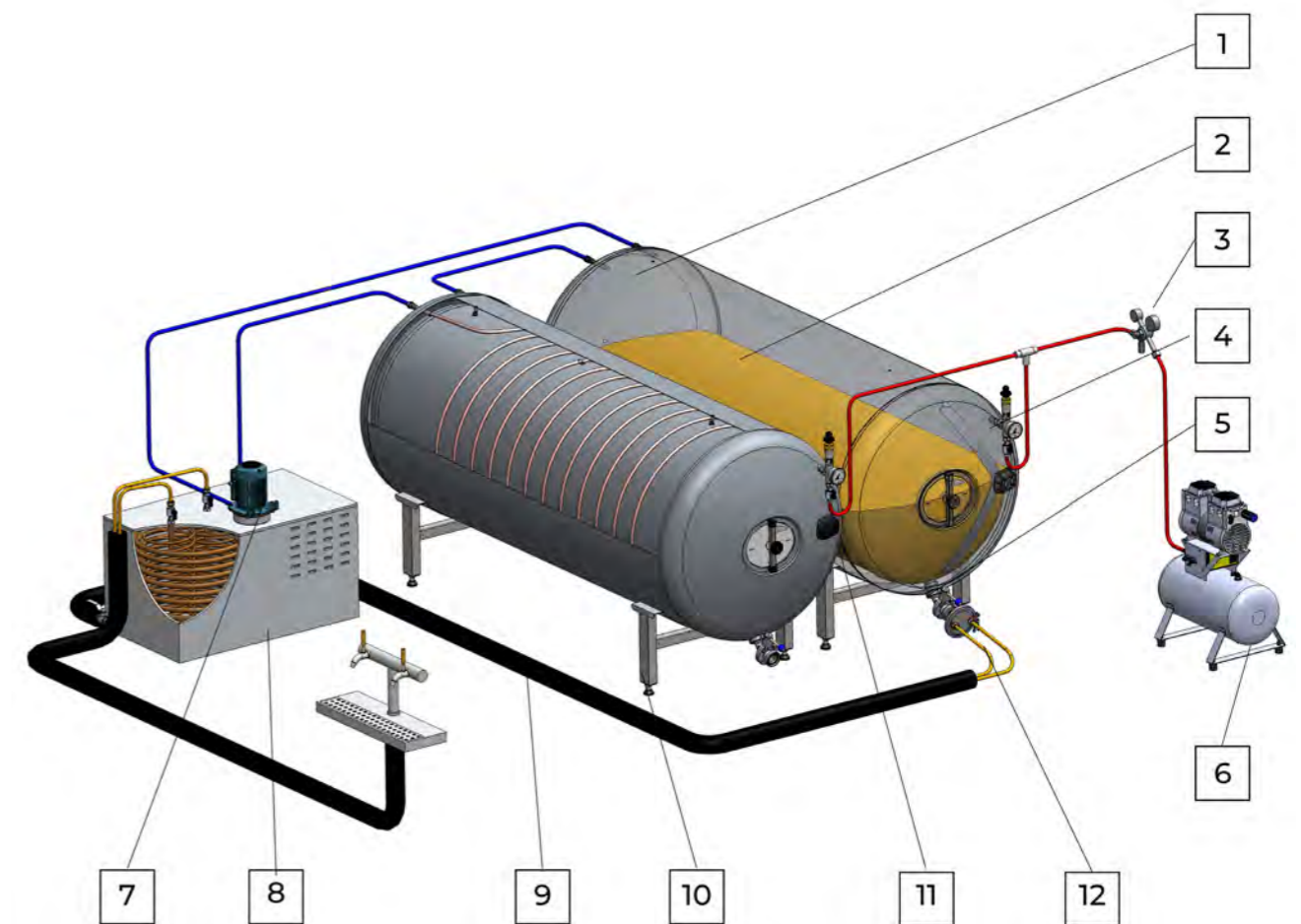



2.5 HL TANKS

HORIZONTAL

2.5 HL INSULATED

Tank versions

Images only as reference



Ø 630

Polyurethane

Art.nr.: 00014756

Weight: 50 KG



Ø 630

Copper old look

Art.nr.: 00023621-30

Weight: 95 KG



Ø 630

Stainless steel

Art.nr.: 00020091

Weight: 90 KG



Ø 630

Copper clear coat

Art.nr.: 00023621-20

Weight: 95 KG



Accessories



Piercing unit

Art.nr.: 00005917



Safety valve

Art.nr.: 00005987



Beerliner

Art.nr.: 00015677

Min. order qt. 20 pieces



Manhole cover

Art.nr.: 00019788

Frames

1A

7 KG

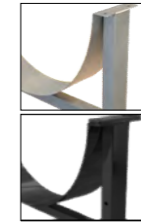
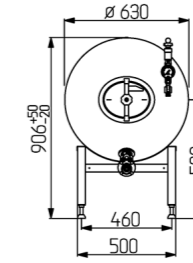
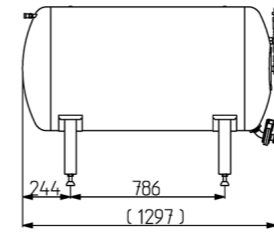

Stainless steel

Art.nr.: 00017408

Painted black

Art.nr.: 00017408-3

2A

17 KG

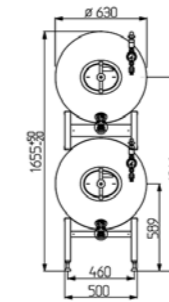
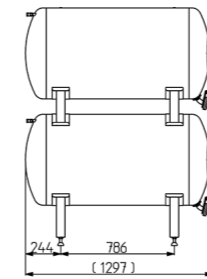

Stainless steel

Art.nr.: 00017410

Painted black

Art.nr.: 00017410-3

3A

25 KG

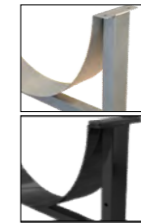
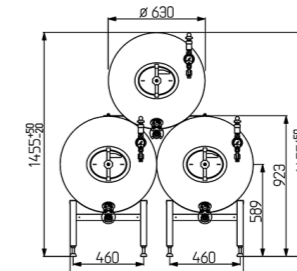
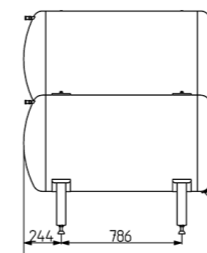

Stainless steel

Art.nr.: 00020094

Painted black

Art.nr.: 00020094-3

3AA

46 KG

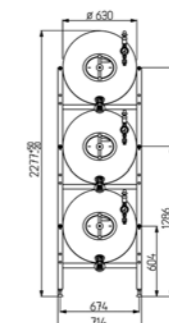
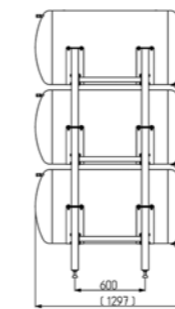

Stainless steel

Art.nr.: 00020095

Painted black

Art.nr.: 00020095-3

1H

15 KG

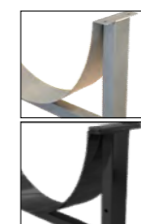
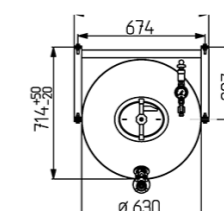
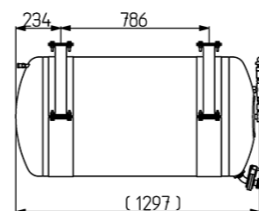

Stainless steel

Art.nr.: 00023720-1

Painted black

Art.nr.: 00023720-3

2.5 HL INSULATED DB

Tank versions

Images only as reference



Ø 700

Polyurethane

Art.nr.: 10006041

Weight: 48 KG



Ø 700

Copper old look

Art.nr.: 10006043-30

Weight: 89 KG



Ø 700

Stainless steel

Art.nr.: 10006042

Weight: 84 KG



Ø 700

Copper clear coat

Art.nr.: 10006043-20

Weight: 89 KG



Accessories



Piercing unit

Art.nr.: 00005917



Safety valve

Art.nr.: 00005987



Beerliner

Art.nr.: 10006222

Min. order qt. 20 pieces



Manhole cover

Art.nr.: 00019788

Frames

1A

7 KG

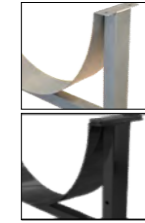
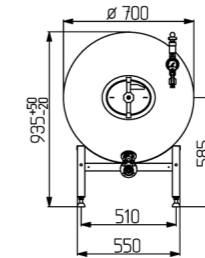
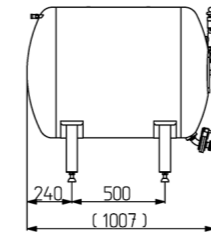

Stainless steel

Art.nr.: 00015671

Painted black

Art.nr.: 00015671-3

2A

17 KG

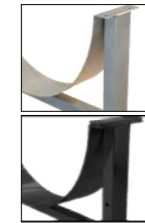
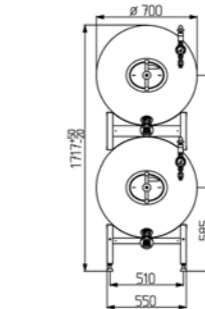
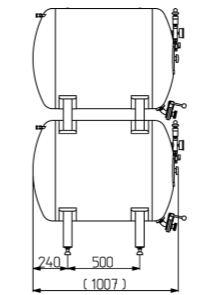

Stainless steel

Art.nr.: 00015672

Painted black

Art.nr.: 00015672-3

3A

25 KG

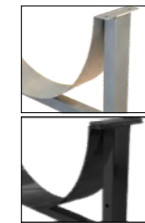
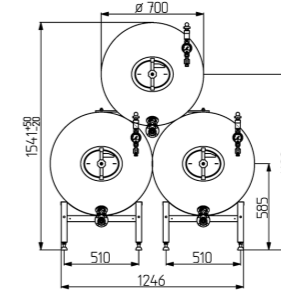
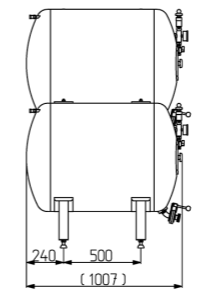

Stainless steel

Art.nr.: 00015800

Painted black

Art.nr.: 00015800-3

3AA

46 KG

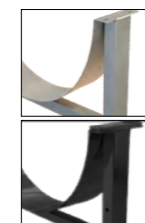
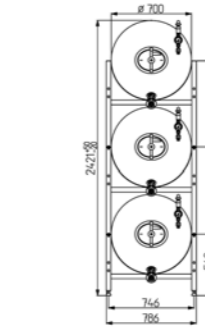
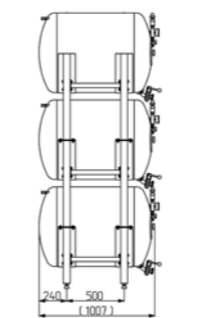

Stainless steel

Art.nr.: 10006334

Painted black

Art.nr.: 10006334-3

1H

15 KG

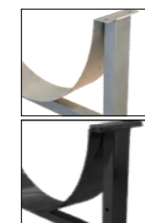
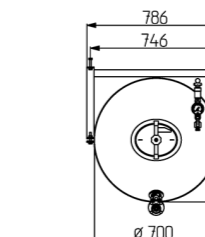
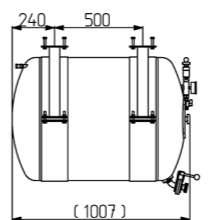

Stainless steel

Art.nr.: 00022379-1

Painted black

Art.nr.: 00022379-3

Prices 2.5 HL INSULATED

Tank 2,5HL H insulated Ø 630 horizontal		
Art. Nr. Duotank	Description	Additional info
00014756	Tank 2.5HL H DW PU 25-G3/4"	Polyurethane
00020091	Tank 2.5HL H DW SS 25-G3/4"	Stainless steel
00020091-1	Tank 2.5HL H DW SS 25-G3/4" Painted	Painted Copper
00020091-2	Tank 2.5HL H DW SS 25-G3/4" Painted	Painted RAL color
00023621-30	Tank 2.5HL H DW CP 25-G3/4" Old look	Copper Plated - Old look
00023621-20	Tank 2.5HL H DW CP 25-G3/4" Polished	Copper Plated - Clear coat

Frames		
Art. Nr. Duotank	Description	Additional info
00017408	Frame 2.5 HL DW 1A	
00017408-3	Frame 2.5 HL DW 1A Painted	Painted black
00023720-1	Frame 2.5 HL DW 1	
00023720-3	Frame 2.5 HL DW 1H Painted	Painted black
00017410	Frame 2.5 HL DW 2A	
00017410-3	Frame 2.5 HL DW 2A Painted	Painted black
00020094	Frame 2.5 HL DW 3A	
00020094-3	Frame 2.5 HL DW 3A Painted	Painted black
00020095	Frame 2.5 HL DW 3AA	
00020095-3	Frame 2.5 HL DW 3AA Painted	Painted black

Accessoires		
Art. Nr. Duotank	Description	Additional info
00005917	Piercing unit	NW 25
00005987	Safety valve 3/4"	5/8" air hose connection
00019788	Manhole cover	
00015677	Inliner 2.5HL H HB7L Ø550 25-45°	Price per box (20pcs)
00015677	Inliner 2.5HL H HB7L Ø550 25-45°	Price per pallet (320 pcs)

Prices 2.5 HL INSULATED DB

Tank 2,5HL H insulated Ø 700 horizontal		
Art. Nr. Duotank	Description	Additional info
10006041	Tank 2.5HL H DW DB PU 25-G3/4"	Polyurethane
10006042	Tank 2.5HL H DW DB SS 25-G3/4"	Stainless steel
10006042-1	Tank 2.5HL H DW DB SS 25-G3/4" Painted	Painted Copper
10006042-2	Tank 2.5HL H DW DB SS 25-G3/4" Painted	Painted RAL color
10006043-30	Tank 2.5HL H DW DB CP 25-G3/4" Old look	Copper Plated - Old look
00023621-20	Tank 2.5HL H DW DB CP 25-G3/4" Polished	Copper Plated - Clear coat

Frames		
Art. Nr. Duotank	Description	Additional info
00015671	Frame 2,5 HL DB / 5HL DW 1A	
00015671-3	Frame 2,5 HL DB / 5HL DW 1A Painted	Painted black
00022379-1	Frame 2,5 HL DB / 5HL DW 1H	
00022379-3	Frame 2,5 HL DB / 5HL DW 1H Painted	Painted black
00015672	Frame 2,5 HL DB / 5HL DW 2A	
00015672-3	Frame 2,5 HL DB / 5HL DW 2A Painted	Painted black
00015800	Frame 2,5 HL DB / 5HL DW 3A	
00015800-3	Frame 2,5 HL DB / 5HL DW 3A Painted	Painted black
10006334	Frame 2,5 HL DB DW 3AA	
10006334-3	Frame 2,5 HL DB DW 3AA Painted	Painted black

Accessoires		
Art. Nr. Duotank	Description	Additional info
00005917	Piercing unit	NW 25
00005987	Safety valve 3/4"	5/8" air hose connection
00019788	Manhole cover	
10006222	Inliner 2.5HL H HB7L Ø630 25-45°	Price per box (20pcs)
10006222	Inliner 2.5HL H HB7L Ø630 25-45°	Price per pallet (320 pcs)

The image shows two large, vertical stainless steel beer tanks standing side-by-side in a room. The tanks are highly reflective and feature circular access ports on their front. They are supported by four legs each. In the background, there are large, multi-paned windows with dark frames, offering a view of a brick building and trees. The floor is made of light-colored wood. A white text box is overlaid on the bottom left of the image.

2.5 HL TANKS
VERTICAL

2.5 HL INSULATED VERTICAL

Tank versions

Images only as reference



Ø 700

Stainless steel

Art.nr.: 10002485

Weight: 95 KG

Ø 700

Painted copper

Art.nr.: 10002485-1

Weight: 97 KG



Ø 700

Copper old look

Art.nr.: 10002487-30

Weight: 100 KG

Ø 700

Copper clear coat

Art.nr.: 10002487-20

Weight: 100 KG

Accessories



Safety valve

Art.nr.: 00005987



Beerliner

Art.nr.: 10006222

Min. order qt. 20 pieces



Piercing unit

Art.nr.: 00005917



Sight glass

Art.nr.: 10006030



Manhole cover

Art.nr.: 00019788



Extension tube

Art.nr.: 10003251

Prices 2.5 HL INSULATED VERTICAL

Tank 2,5HL V insulated Ø 700 vertical

Art. Nr. Duotank	Description	Additional info
10002485	Tank 2,5HL V DW SS 25-G3/4"	Stainless steel
10002485-1	Tank 2,5HL V DW SS 25-G3/4" Painted	Painted copper
10002487-30	Tank 2,5HL V DW CP 25-G3/4" Old look	Copper old look
10002487-20	Tank 2,5HL V DW 25-G3/4" Polished	Copper clear coat

Accessoires

Art. Nr. Duotank	Description	Additional info
00005917	Piercing unit	NW 25
00005987	Safety valve 3/4"	5/8" air hose connection
10006030	Option: Sight glass	
10003251	Option extension tube safety valve	
00019788	Manhole cover	
10006222	Inliner 2.5HL H HB7L Ø630 25-45°	Price per box (20pcs)
10006222	Inliner 2.5HL H HB7L Ø630 25-45°	Price per pallet (320 pcs)





5 HL TANKS
HORIZONTAL

5 HL INSULATED

Tank versions

Images only as reference



Ø 700

Polyurethane

Art.nr.: 00014755

Weight: 72 KG



Ø 700

Copper old look

Art.nr.: 00020092-30

Weight: 137 KG



Ø 700

Stainless steel

Art.nr.: 00019559

Weight: 132 KG



Ø 700

Copper clear coat

Art.nr.: 00020092-20

Weight: 137 KG



Accessories



Safety valve

Art.nr.: 00005987



Piercing unit

Art.nr.: 00005917



Beerliner

Art.nr.: 00006102

Min. order qt. 20 pieces



Manhole cover

Art.nr.: 00019788

Frames

1A

7 KG

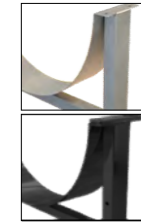
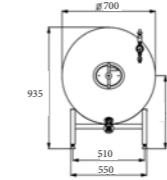
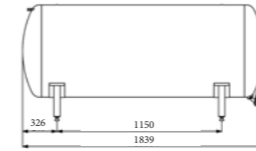

Stainless steel

Art.nr.: 00015671

Painted black

Art.nr.: 00015671-3

2A

17 KG

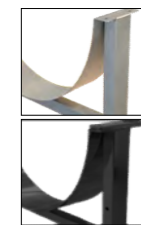
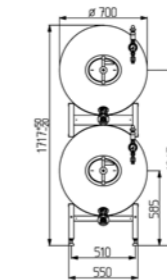
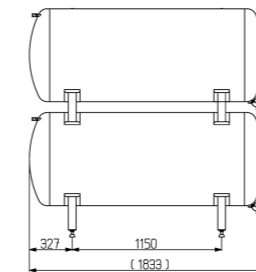

Stainless steel

Art.nr.: 00015672

Painted black

Art.nr.: 00015672-3

3A

25 KG

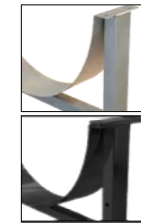
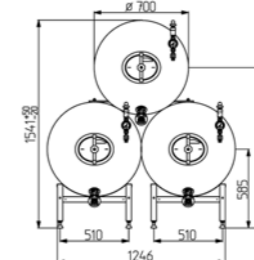
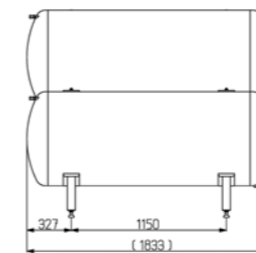

Stainless steel

Art.nr.: 00015800

Painted black

Art.nr.: 00015800-3

3AA

46 KG

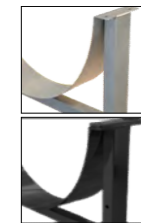
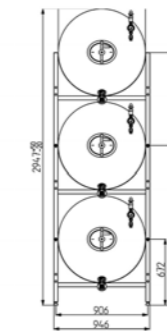
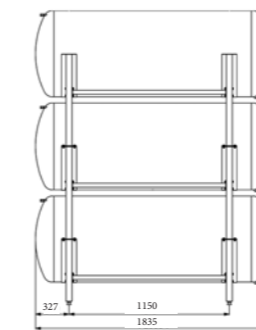

Stainless steel

Art.nr.: 10006334

Painted black

Art.nr.: 10006334-3

1H

15 KG

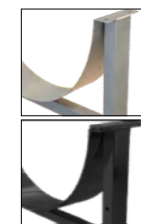
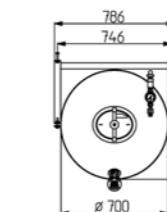
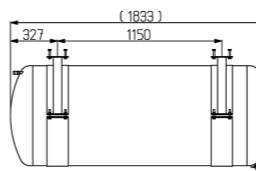

Stainless steel

Art.nr.: 00022379-1

Painted black

Art.nr.: 00022379-3

5 HL INSULATED DB

Tank versions

Images only as reference



Ø 860

Polyurethane

Art.nr.: 10006046

Weight: 67 KG



Ø 860

Copper old look

Art.nr.: 10006048-30

Weight: 111 KG



Ø 860

Stainless steel

Art.nr.: 10006047

Weight: 106 KG



Ø 860

Copper clear coat

Art.nr.: 10006048-20

Weight: 111 KG

Accessories



Piercing unit

Art.nr.: 00005917



Safety valve

Art.nr.: 00005987



Beerliner

Art.nr.: 00019375

Min. order qt. 20 pieces



Manhole cover

Art.nr.: 00019788

Frames

1A

10 KG

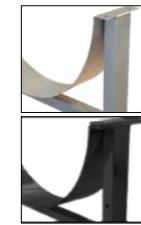
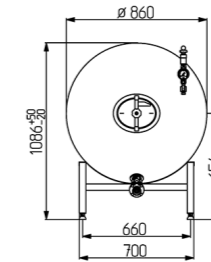
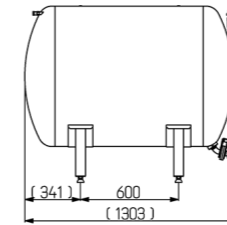

Stainless steel

Art.nr.: 00015675

Painted black

Art.nr.: 00015675-3

2A

25 KG

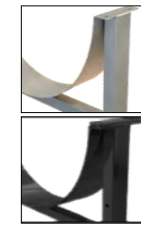
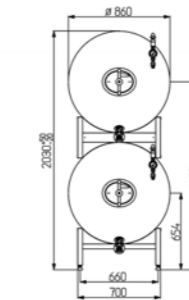
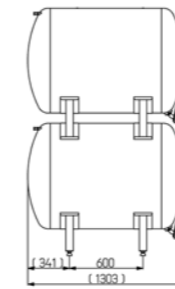

Stainless steel

Art.nr.: 00015676

Painted black

Art.nr.: 00015676-3

3A

33 KG

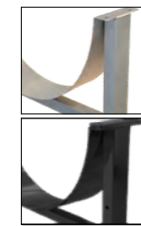
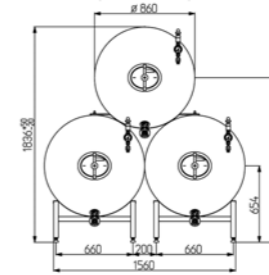
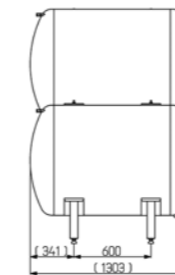

Stainless steel

Art.nr.: 00017369

Painted black

Art.nr.: 00017369-3

3AA

60 KG

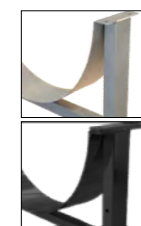
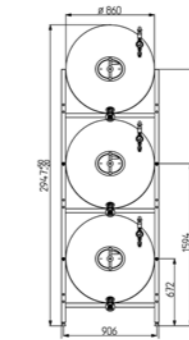
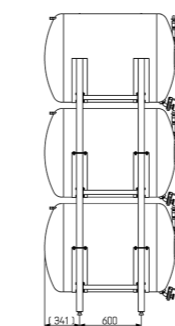

Stainless steel

Art.nr.: 10005110

Painted black

Art.nr.: 10005110-3

1H

20 KG

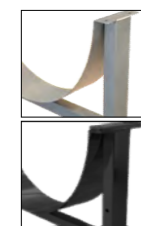
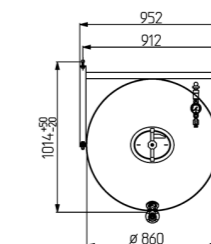
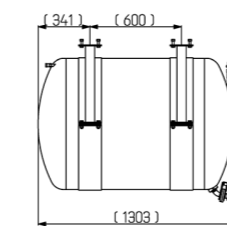

Stainless steel

Art.nr.: 10000134

Painted black

Art.nr.: 10000134-3

Prices 5 HL INSULATED

Tank 5HL H insulated Ø 700 horizontal		
Art. Nr. Duotank	Description	Additional info
00014755	Tank 5HL H DW PU 25-G3/4"	Polyurethane
00019559	Tank 5HL H DW SS 25-G3/4"	Stainless steel
00019559-1	Tank 5HL H DW SS 25-G3/4" Painted	Painted Copper
00019559-2	Tank 5HL H DW SS 25-G3/4" Painted	Painted RAL color
00020092-30	Tank 5HL H DW CP 25-G3/4" Old look	Copper Plated - Old look
00020092-20	Tank 5HL H DW CP 25-G3/4" Polished	Copper Plated - Clear coat

Frames		
Art. Nr. Duotank	Description	Additional info
00015671	Frame 2,5 HL DB / 5HL DW 1A	
00015671-3	Frame 2,5 HL DB / 5HL DW 1A Painted	Painted black
00022379-1	Frame 2,5 HL DB / 5HL DW 1H	
00022379-3	Frame 2,5 HL DB / 5HL DW 1H Painted	Painted black
00015672	Frame 2,5 HL DB / 5HL DW 2A	
00015672-3	Frame 2,5 HL DB / 5HL DW 2A Painted	Painted black
00015800	Frame 2,5 HL DB / 5HL DW 3A	
00015800-3	Frame 2,5 HL DB / 5HL DW 3A Painted	Painted black
10006334	Frame 2,5 HL DB DW 3AA	
10006334-3	Frame 2,5 HL DB DW 3AA Painted	Painted black

Accessoires		
Art. Nr. Duotank	Description	Additional info
00005917	Piercing unit	NW 25
00005987	Safety valve 3/4"	5/8" air hose connection
00019788	Manhole cover	
00006102	INL 5 HL H HB7L Ø630 25 45°	Price per box (20pcs)
00006102	INL 5 HL H HB7L Ø630 25 45°	Price per pallet (320 pcs)

Prices 5 HL INSULATED DB

Tank 5HL H insulated Ø 860 horizontal		
Art. Nr. Duotank	Description	Additional info
10006046	Tank 5HL H DW DB PU 25-G3/4"	Polyurethane
10006047	Tank 5HL H DW DB SS 25-G3/4"	Stainless steel
10006047-1	Tank 5HL H DW DB SS 25-G3/4" Painted	Painted Copper
10006047-2	Tank 5HL H DW DB SS 25-G3/4" Painted	Painted RAL color
10006048-30	Tank 5HL H DW DB CP 25-G3/4" Old look	Copper Plated - Old look
10006048-20	Tank 5HL H DW DB CP 25-G3/4" Polished	Copper Plated - Clear coat

Frames DB		
Art. Nr. Duotank	Description	Additional info
00015675	Frame 5 HL DB / 10HL DW 1A	
00015675-3	Frame 5 HL DB / 10HL DW 1A Painted	Painted black
10000134	Frame 5 HL DB / 10HL DW 1H	
10000134-3	Frame 5 HL DB / 10HL DW 1H Painted	Painted black
00015676	Frame 5 HL DB / 10HL DW 2A	
00015676-3	Frame 5 HL DB / 10HL DW 2A Painted	Painted black
00017369	Frame 5 HL DB / 10HL DW 3A	
00017369-3	Frame 5 HL DB / 10HL DW 3A Painted	Painted black
10005110	Frame 5 HL DB DW 3AA	
10005110-3	Frame 5 HL DB DW 3AA Painted	Painted black

Accessoires		
Art. Nr. Duotank	Description	Additional info
00005917	Piercing unit	NW 25
00005987	Safety valve 3/4"	5/8" air hose connection
00019788	Manhole cover	
00019375	INL 5 HL DB H HB7L Ø790 25 45°	Price per box (20pcs)
00019375	INL 5 HL DB H HB7L Ø790 25 45°	Price per pallet (320 pcs)



5 HL TANKS
VERTICAL

5 HL INSULATED VERTICAL

Tank versions slim

Images only as reference



Ø 700

Stainless steel

Art.nr.: 10008958

Weight: 180 KG

Ø 700

Painted copper

Art.nr.: 10008958-10

Weight: 182 KG

Ø 700

Copper old look

Art.nr.: 10008958-30

Weight: 185 KG

Ø 700

Clear Coat

Art.nr.: 10008958-20

Weight: 185 KG

Tank versions wide

Images only as reference



Ø 860

Stainless steel

Art.nr.: 10002491

Weight: 160 KG

Ø 860

Painted copper

Art.nr.: 10002491-1

Weight: 160 KG

Ø 860

Copper old look

Art.nr.: 10002493-30

Weight: 165 KG

Ø 860

Clear Coat

Art.nr.: 10002493-20

Weight: 165 KG

Accessories



Safety valve

Art.nr.: 00005987



Beerliner

Art.nr.: 10008685

Min. order qt. 20 pieces



Piercing unit

Art.nr.: 00005917



Sight glass

Art.nr.: 10006030



Manhole cover

Art.nr.: 00019788



Extension tube

Art.nr.: 10003251

Prices 5 HL INSULATED VERTICAL

Tank versions slim Ø 700		
Art. Nr. Duotank	Description	Additional info
10002491	Tank 5HL V DW SS 25-G3/4"	Stainless steel
10002491-1	Tank 5HL V DW SS 25-G3/4" Painted	Painted Copper
10002493-30	Tank 5HL V DW CP 25-G3/4" Old look	Copper Old look
10002493-20	Tank 5HL V DW CP 25-G3/4" Polished	Copper clear coat

Accessoires		
Art. Nr. Duotank	Description	Additional info
00005917	Piercing unit	NW 25
00005987	Safety valve 3/4"	5/8" air hose connection
10006030	Option: Sight glass	
10003251	Option extension tube safety valve	
00019788	Manhole cover	
10008685	INL 5 HL DB V HB7L Ø630 25 45°	Price per box (20pcs)
10008685	INL 5 HL DB V HB7L Ø630 25 45°	Price per pallet (320 pcs)

Tank versions wide Ø 860		
Art. Nr. Duotank	Description	Additional info
10008958	Tank 5HL V DW SS 25-G3/4" SS	Stainless steel
10008958-10	Tank 5HL V DW SS 25-G3/4" Painted	Painted Copper
10008958-30	Tank 5HL V DW SS 25-G3/4" Old look	Copper Old look
10008958-20	Tank 5HL V DW SS 25-G3/4" Polished	Copper clear coat

Accessoires		
Art. Nr. Duotank	Description	Additional info
00005917	Piercing unit	NW 25
00005987	Safety valve 3/4"	5/8" air hose connection
10006030	Option: Sight glass	
10003251	Option extension tube safety valve	
00019788	Manhole cover	
00006089	INL 5 HL DB V HB7L Ø790 25 45°	Price per box (20pcs)
00006089	INL 5 HL DB V HB7L Ø790 25 45°	Price per pallet (320 pcs)



10 HL TANKS
HORIZONTAL

10 HL INSULATED

Tank versions

Images only as reference



Ø 860

Polyurethane

Art.nr.: 00014750

Weight: 110 KG



Ø 860

Copper old look

Art.nr.: 00020100-30

Weight: 186 KG



Ø 860

Stainless steel

Art.nr.: 00019560

Weight: 181 KG



Ø 860

Copper clear coat

Art.nr.: 0020100-20

Weight: 186 KG



Accessories



Piercing unit

Art.nr.: 00005917



Safety valve

Art.nr.: 00005987



Beerliner

Art.nr.: 00015678

Min. order qt. 15 pieces



Manhole cover

Art.nr.: 00019788

Frames

1A

10 KG

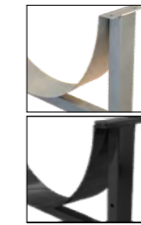
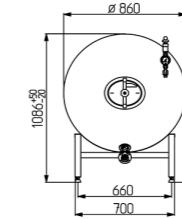
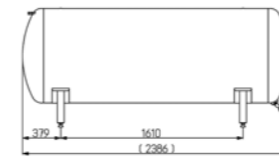

Stainless steel

Art.nr.: 00015675

Painted black

Art.nr.: 00015675-3

2A

25 KG

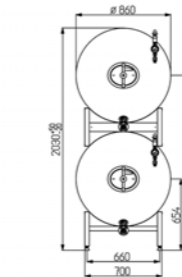
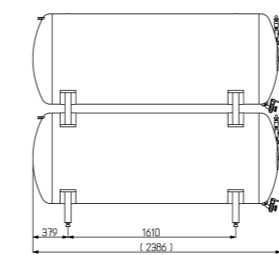

Stainless steel

Art.nr.: 00015676

Painted black

Art.nr.: 00015676-3

3A

33 KG

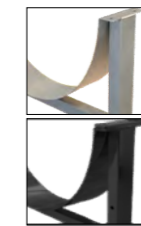
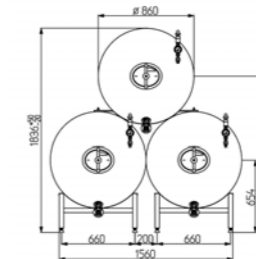
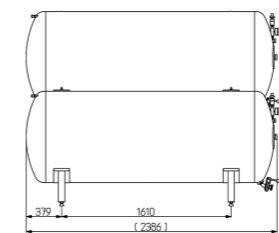

Stainless steel

Art.nr.: 00017369

Painted black

Art.nr.: 00017369-3

3AA

64 KG

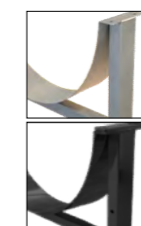
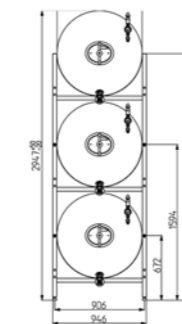
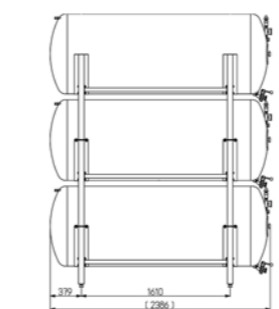

Stainless steel

Art.nr.: 00020096

Painted black

Art.nr.: 00020096-3

1H

20 KG

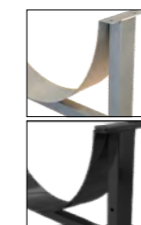
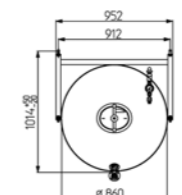
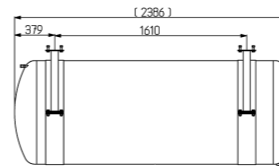

Stainless steel

Art.nr.: 100000134

Painted black

Art.nr.: 100000134-3

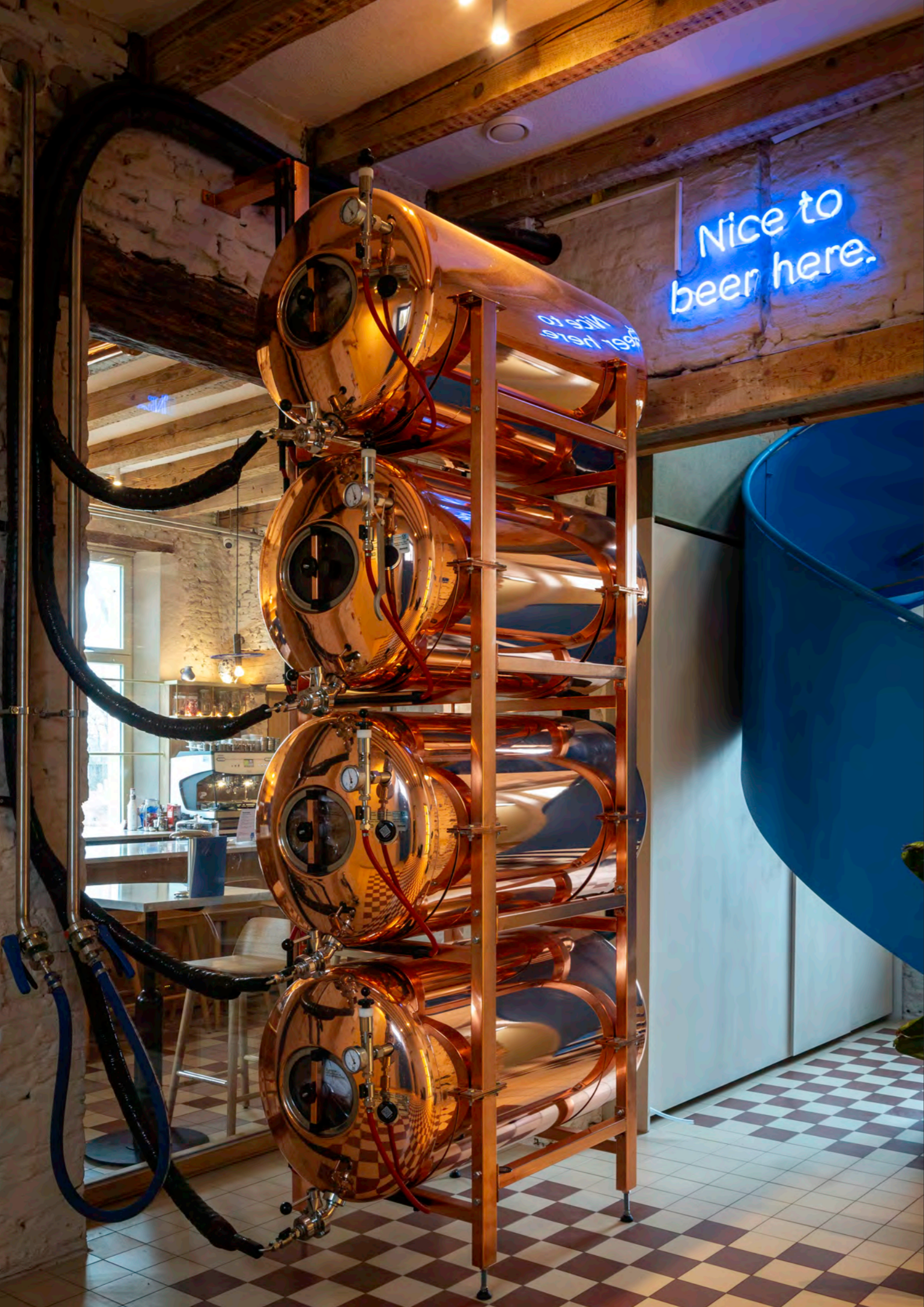

Prices 10 HL INSULATED

Tank 10HL H insulated Ø 860 horizontal		
Art. Nr. Duotank	Description	Additional info
00014750	Tank 10HL H DW PU 25-G3/4"	Polyurethane
00019560	Tank 10HL H DW SS 25-G3/4"	Stainless steel
00019560-1	Tank 10HL H DW SS 25-G3/4" Painted	Painted Copper
00019560-2	Tank 10HL H DW SS 25-G3/4" Painted	Painted RAL color
00020100-30	Tank 10HL H DW CP 25-G3/4" Old look	Copper Plated - Old look
00020100-20	Tank 10HL H DW CP 25-G3/4" Polished	Copper Plated - Clear coat

Frames		
Art. Nr. Duotank	Description	Additional info
00015675	Frame 5 HL DB / 10HL DW 1A	
00015675-3	Frame 5 HL DB / 10HL DW 1A painted	Painted black
10000134	Frame 5 HL DB / 10HL DW 1H	
10000134-3	Frame 5 HL DB / 10HL DW 1H painted	Painted black
00015676	Frame 5 HL DB / 10HL DW 2A	
00015676-3	Frame 5 HL DB / 10HL DW 2A painted	Painted black
00017369	Frame 5 HL DB / 10HL DW 3A	
00017369-3	Frame 5 HL DB / 10HL DW 3A painted	Painted black
10005110	Frame 5 HL DB DW 3AA	
10005110-3	Frame 5 HL DB DW 3AA painted	Painted black
10005110	Frame 10 HL DW 3AA	
10005110-3	Frame 10 HL DW 3AA painted	Painted black

Accessoires		
Art. Nr. Duotank	Description	Additional info
00005917	Piercing unit	NW 25
00005987	Safety valve 3/4"	5/8" air hose connection
00019788	Manhole cover	
00015678	INL 10 HL H HB7L Ø790 25 45°	Price per box (15 pcs)
00015678	INL 10 HL H HB7L Ø790 25 45°	Price per pallet (240 pcs)



COMPONENTS

Components



Cooler (3/4 HP)
87 Liter
Art. nr.: 00022020



DAC Compressor
DAC25: 00022091-1



Pump
(Grundfoss SPK 5-2)
Art. nr. 00019977



Beer manifold caps
2 exit 5/8"
Art. nr.: 00005938



Beer manifold caps
4 exit 5/8"
Art. nr.: 00005940



Beer manifold caps
6 exit 5/8"
Art. nr.: 00005957

More / less exits or different connections upon request

Prices Components

Components		
Art. Nr. Duotank	Description	Additional info
00022091-1	Compressor DAC 25 2.0	
00022020	Cooler (3/4 HP)	
00019977	Pump (Grundfoss SPK-2)	

Beer Manifolds		
Art. Nr. Duotank	Description	Additional info
00021788	Beer Manifolds 25-80 1 x 58	
00005938	Beer Manifolds 25-80 2 x 58	
00005939	Beer Manifolds 25-80 3 x 58	
00005940	BeerManifolds 25-80 4 x 58	
00005941	Beer Manifolds 25-80 5 x 58	
00005957	Beer Manifolds 25-100 6 x 58	
00005958	Beer Manifolds 25-100 7 x 58	
00005959	Beer Manifolds 25-100 8 x 58	

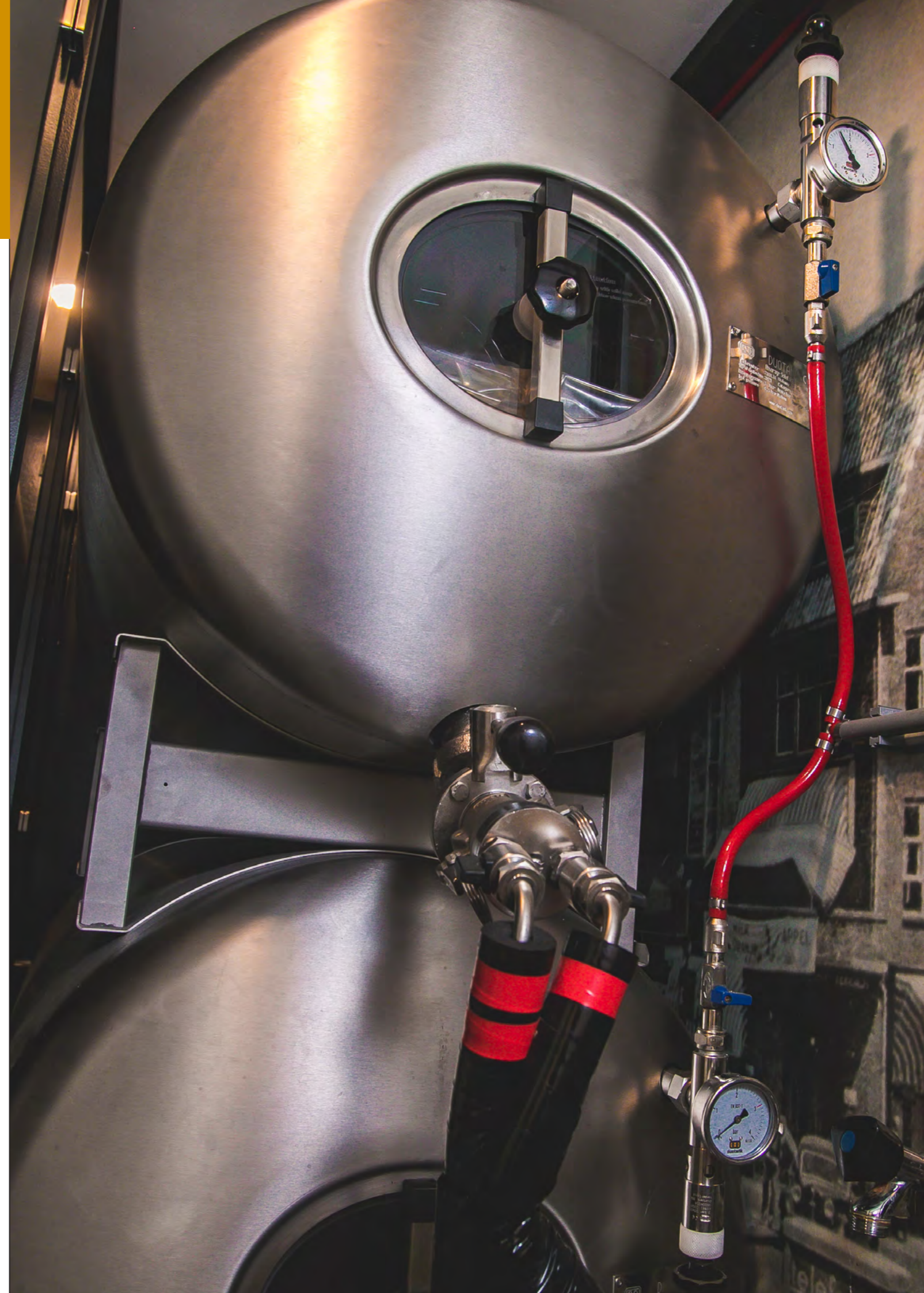

NON-INSULATED TANKS



Non-Insulated Horizontal

Tank versions

Images only as reference

Ø 550	Ø 630
Tank 2,5HL standard	Tank 2,5HL DB
Stainless steel	Stainless steel
Art.nr.: 00014841	Art.nr.: 10006040
Weight: 40 KG	Weight: 38 KG



Ø 630	Ø 700	Ø 700
Tank 5HL standard	Tank 5HL DB	Tank 10HL
Stainless steel	Stainless steel	Stainless steel
Art.nr.: 00014839	Art.nr.: 10006045	Art.nr.: 00014837
Weight: 63 KG	Weight: 57 KG	Weight: 98 KG

Accessories



Piercing unit
Art.nr.: 00005917



Safety valve
Art.nr.: 00005987



Sight glass
Art.nr.: 10006028



Manhole cover
Art.nr.: 00019788

Non-Insulated Vertical

Tank versions

Images only as reference

Ø 550	Ø 630
Tank 2,5HL V	Tank 2,5HL V
Stainless steel	Stainless steel
Art.nr.: 10006026	Art.nr.: 10002484
Weight: 49 KG	Weight: 49 KG

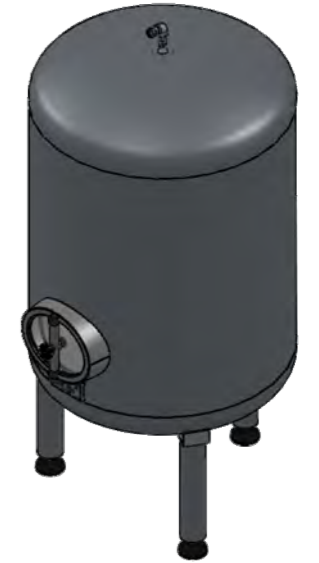

Ø 630	Ø 790	Ø 790
Tank 2,5HL V	Tank 5HL V	Tank 5HL V
Painted copper	Stainless steel	Painted copper
Art.nr.: 10002484-1	Art.nr.: 10002490	Art.nr.: 10002490-1
Weight: 73 KG	Weight: 73 KG	Weight: 80 KG

Accessories



Piercing unit
Art.nr.: 00005917



Safety valve
Art.nr.: 00005987



Sight glass
Art.nr.: 10006028



Manhole cover
Art.nr.: 00019788

Prices Non-Insulated Horizontal

Non-insulated horizontal tanks		
Art. Nr. Duotank	Description	Additional info
00014841	Tank 2.5HL H SW 25-G3/4"	Stainless steel
10006040	Tank 2.5HL H SW DB 25-G3/4"	Stainless steel
00014839	Tank 5HL H SW 25-G3/4"	Stainless steel
10006045	Tank 5HL H SW DB 25-G3/4"	Stainless steel
00014837	Tank 10HL H SW 25-G3/4"	Stainless steel

Frames		
Art. Nr. Duotank	Description	Additional info
00017397	Frame 2.5 HL SW 1A	
00017406	Frame 2.5 HL SW 2A	
00015669	Frame 2,5 HL DB / 5HL SW 1A	
00015670	Frame 2,5 HL DB / 5HL SW 2A	
00016697	Frame 2,5 HL DB / 5HL SW 3A	
00017089	Frame 5 HL SW 3AA	
00015673	Frame 5 HL DB / 10HL SW 1A	
00015674	Frame 5 HL DB / 10HL SW 2A	
00020093	Frame 5 HL DB / 10HL SW 3A	
00017647	Frame 5 HL DB / 10HL SW 3AA	

Accessoires		
Art. Nr. Duotank	Description	Additional info
00005917	Piercing unit	NW 25
00005987	Safety valve 3/4"	5/8" air hose connection
10006028	Option: Sight glass	
00019788	Manhole cover	

Prices Non-Insulated Vertical

Non-insulated vertical tanks		
Art. Nr. Duotank	Description	Additional info
10006026	Tank 2,5HL V SW 25-G3/4" (manhole bottom)	
10002484	Tank 2,5HL V SW 25-G3/4"	
10002484-1	Tank 2,5HL V SW 25-G3/4"	Painted copper
10002490	Tank 5HL V SW 25-G3/4"	
10002490-1	Tank 5HL V SW 25-G3/4"	Painted copper

Accessoires		
Art. Nr. Duotank	Description	Additional info
00005917	Piercing unit	NW 25
00005987	Safety valve 3/4"	5/8" air hose connection
10006028	Option: Sight glass	
00019788	Manhole cover	



duotank
TANKBEER SYSTEMS

Duotank Beverage Solutions b.v. - Petunialaan 5
5582 HA - Waalre (NL)
T 040-221 22 72 - E. sales@duotank.nl
www.duotank.com